

FOAM CHAMBER

MODEL - FCA & FCA-S



TECHNICAL DATA

MODELS	FCA 50	Carbon Steel construction
	FCA 65	
	FCA 80	
	FCA 100	
	FCA 150	
	FCA-S 50	Stainless Steel construction
	FCA-S 65	
	FCA-S 80	
	FCA-S 100	
	FCA-S 150	
INLET SIZE	50, 65, 80, 100 NB & 150 NB	
WORKING PRESSURE	Minimum 2.8 kg/sq.cm (40 psi) Maximum 7 kg/sq.cm (100 psi)	
FLANGE CONNECTION	ANSI B16.5 Class 150#SORF	
WEIGHT (Approx.)	50 NB	29.9 kg
	65 NB	34.5 kg
	80 NB	49.5 kg
	100 NB	72.0 kg
	150 NB	110.0 kg
VAPOUR SEAL RUPTURE PRESSURE	0.7 to 1.75 kg/sq.cm (10 psi to 25 psi) Running water/ water foam solution pressure at inlet of Foam Chamber	
MAXIMUM PERMISSIBLE BACK PRESSURE ON VAPOUR SEAL	0.07 kg/sq.cm (1.0 psi)	
VAPOUR SEAL	Glass standard supply, Graphite optional only with FM Approvals	
DEFLECTOR	Solid or Split Deflector	
FINISH	Red RAL 3001 standard supply Other shades optional	
APPROVAL	UL Listed & FM Approved	
ORDERING INFORMATION	a) Model & Size b) Flow & Pressure at inlet of each Foam Chamber c) Inlet, outlet flange specification d) Type of Deflector e) Type of Foam concentrate used f) Tank number / Tag number	

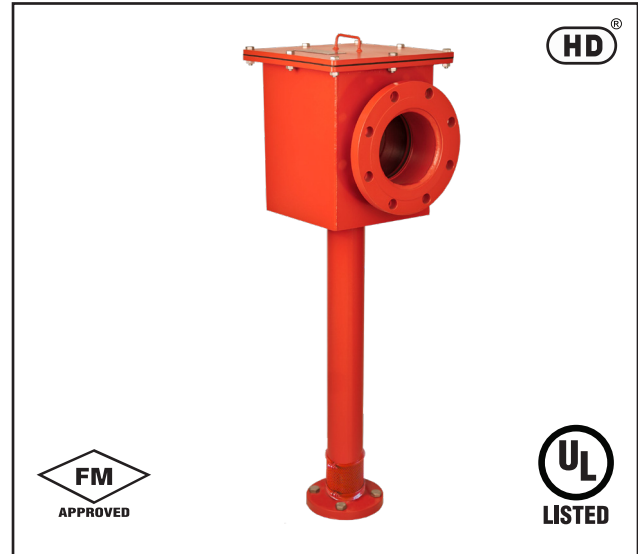

FEATURES

- UL Listed & FM Approved
- Heavy duty welded construction with choice of Carbon Steel or Stainless Steel material
- Frangible Glass Vapour Seal
- Controlled Air Flow proportional to liquid flow for optimum foam quality and rupture of vapour seal in narrow pressure tolerances for increased reliability
- Field replaceable orifice plate fitted with Foam Chamber

APPLICATION

Foam Chamber is used in one of the most common applications to protect vertical fixed roof (cone) liquid storage tanks, with or without internal floating roof with the low expansion foam system. The application of foam is on the basis that the risk comprises the total surface area of the fuel. The foam system design guidelines generally used are in accordance with NFPA-11 standard.

Foam Chambers are defined by NFPA-11 as Type II discharge outlets for delivering foam to the surface of a flammable liquid. Foam Chambers are widely used with the Balance Pressure Foam Proportioning System, Bladder Tank Proportioner or Foam Tender.

SPECIFICATION

Foam Chamber is an air aspirating foam discharge device, covering wide range of flow from 75 to 3300 litres per minute at 2.8 to 7 kg/sq.cm inlet pressure. The Foam Chamber contains a vapour seal to prevent the entry of fuel vapour into the foam chamber and the foam solution pipe. Each foam chamber is supplied with an orifice plate, designed for the required flow and inlet pressure. The orifice is field replaceable in the event of change in design parameters.

Foam is produced by introducing air into the foam solution stream. The inlet of foam chamber is designed to create venturi jet which draws air into the foam solution stream. Air is drawn into the foam solution through the holes located on the foam chamber covered with stainless steel screen to exclude nesting birds and insects. The aerated foam is directed into the deflector for gentle application of the expanded foam. The deflectors are available in different models.

Removal of cover plate from the top of the chamber allows the system to be tested and a sample of the expanded foam can be collected without removing the vapour seal or disconnecting the foam chamber from the tank. Frangible glass bursting disc/graphite (vapour seal) can be replaced easily.

The vapour seal is designed to rupture within 0.7 to 1.75 kg/sq.cm (10 to 25 psi) pressure at inlet flange of Foam Chamber, as required by NFPA, UL and FM standard. The vapour seal will withstand maximum back pressure of 0.07 kg/sq.cm (1.0 psi) or equal to 686 mm of water column as specified by API for welded storage tank. If the requirement exceeds 0.07 kg/sq.cm (1.0 psi) as in case of nitrogen blanketing system, then this equipment may not be suitable.

The vapour seal is frangible glass. Vapour seal is supplied with holder and for spares it can be with or without holder. The 'O' ring used for seal are Nitrile Rubber and optional Viton is recommended for polar solvent.

SYSTEM DESIGN REQUIREMENT

The NFPA-11, a standard for low expansion foam, provides the essential requirements of an appropriate designed foam pouring system, these are identified and outlined as below:

The Foam Deflector is used with the Foam Chamber.

The aerated foam from the Foam Chamber is directed in to the deflector for the gentle application of the expanded foam. The deflector reduces the expanded foam velocity and allows the foam to slide down the tank wall.

(a) Number of Foam Chamber:

The number of foam chambers required is determined by tank diameter. Where two or more foam chambers are required, they shall be spaced equally around the tank periphery and each Foam Chamber shall be sized to deliver foam at an approximately same rate. Please refer graph to select unit that will provide required minimum foam solution application rate at the available operating pressure of the Foam Chamber.

For minimum number of Foam Chamber requirement, kindly follow the recommendations as per NFPA/OISD or as per the governmental codes or ordinances wherever applicable.

(b) Minimum Foam Solution Application Rate:

The minimum foam solution application rate is the rate at which the water and foam concentrate in correctly proportioned ratio should be delivered to the surface of a storage tank under protection to control and extinguish the fire.

For minimum application rate requirement, follow the recommendations as per NFPA/OISD or governmental codes or ordinances wherever applicable.

TESTING & MAINTENANCE

Carefully unpack Foam Chamber. While unpacking and installation it is to be handled with care and shocks to be avoided. Check visually for any damages. While installing ensure that Foam Chamber is not under stress due to any misalignments in installation or variations of system piping. Ensure that the strainer assembly is clear from any blockages or damages. If strainer assembly is either blocked or damaged, it will adversely affect the performance of the equipment.

Qualified and trained person must commission the system. After few initial successful tests, an authorized person must be trained to perform inspection and testing of the system.

It is recommended to carry out physical inspection of the system regularly. The system must be fully tested at least once in a year or in accordance with applicable NFPA/OISD standards or in accordance with authority having local jurisdiction.

Do not turn off the system or any valve to make repair or test the system, without placing a roving Fire Patrol in the area covered by the system. The Patrol should continue until the system is put back in service. Also inform the local security guard and control alarm station, so as to avoid false alarm.

Each system is to be flushed properly. The vapour seal must be replaced if the system has been operated.

Normal testing of the chamber can be carried out by removing the cover plate from the top of the chamber. This allows the system to draw a sample of the expanded foam without removing the vapour seal or disconnecting the Foam Chamber from the tank.

The air screen is to be inspected periodically for the obstruction of air inlet holes. If any obstruction is noticed, remove the same and flush if necessary.

It is recommended to have regular maintenance programme to inspect the Vapour Seal Chamber discharge area and deflector for possible deposit or obstruction.

The owner is responsible for the testing, inspection & maintenance of the Foam Chamber.

CAUTION

Do not install Foam chambers on pressured storage tanks (Inert gas blanketed tanks) and storage tanks containing products, which may attack the foam chamber standard construction material.

Maximum permissible back pressure on vapour seal is 0.07 kg/sq.cm (1.0 psi)

NOTE:

1. A PROVISION IS TO BE MADE FOR PRESSURE GAUGE MOUNTING AT INLET OF FOAM CHAMBER, WHICH MAY BE PLUGGED AFTER SUCCESSFUL COMMISSIONING OF THE SYSTEM. THIS PROVISION WILL HELP TO ANALYSE THE SYSTEM WHILE COMMISSIONING.
2. FM APPROVAL AND UL LISTING OF EQUIPMENT ARE VALID ONLY WHEN USED WITH HD FOAM CONCENTRATE IN A MANNER AS LISTED AND AS PER FM APPROVAL DATA.
3. FM APPROVAL IS VALID ONLY WHEN TOTAL SYSTEM IS HAVING FM APPROVED PRODUCT.
4. REFER TO THE INDIVIDUAL FOAM UL LISTING AND FM APPROVAL, FOR LIMITATION WITH EACH FOAM CONCENTRATE AND FOAM CHAMBER.

Selection of HD Foam Chamber:

TABLE-1 gives the K-Factor of Foam Chamber at various pressures for selection of correct size of Foam Chamber. UL & FM Approvals have different Flow/K-factors.

TABLE-I

APPROVALS	UL LISTED	FM APPROVED	
WORKING PRESSURE	2.8 To 7 kg/sq.cm	2.8 To 7 kg/sq.cm	3.5 To 7 kg/sq.cm
FOAM CONCENTRATE	AFFF3% & AR-AFFF 3X3%	AFFF 3%	AR-AFFF 3X3%
MODELS	K-FACTOR	K-FACTOR	
FCA 50 & FCA-S 50	44.8 To 126.9	--	--
FCA 65 & FCA-S 65	89.6 To 207.8	92.6 To 200.6	84.5 To 217.4
FCA 80 & FCA-S 80	179.2 To 385.9	184 To 429	167.8 To 396
FCA 100 & FCA-S 100	358.5 To 907.01	370.5 To 960	320.7 To 952.5
FCA 150 & FCA-S 150	----	884.5 To 1247.3	783 To 1247.4

To select the size of the Foam Chamber use the following formula:

$$Q = K \sqrt{P}$$

Q = Total solution flow in litres per minute

K = Constant for Foam Chamber

P = Inlet pressure in kg/sq.cm.

FOAM CHAMBER

MODEL	INLET SIZE	OUTLET SIZE	DIMENSIONS in millimeter (Approximate)		
			A	B	C
FCA 50 & FCA-S 50	50NB	80NB	676	520	175
FCA 65 & FCA-S 65	65NB	100NB	756	600	175
FCA 80 & FCA-S 80	80NB	150NB	1093	908	225
FCA 100 & FCA-S 100	100NB	200NB	1221	996	275
FCA 150 & FCA-S 150	150NB	250NB	1250	1018	325

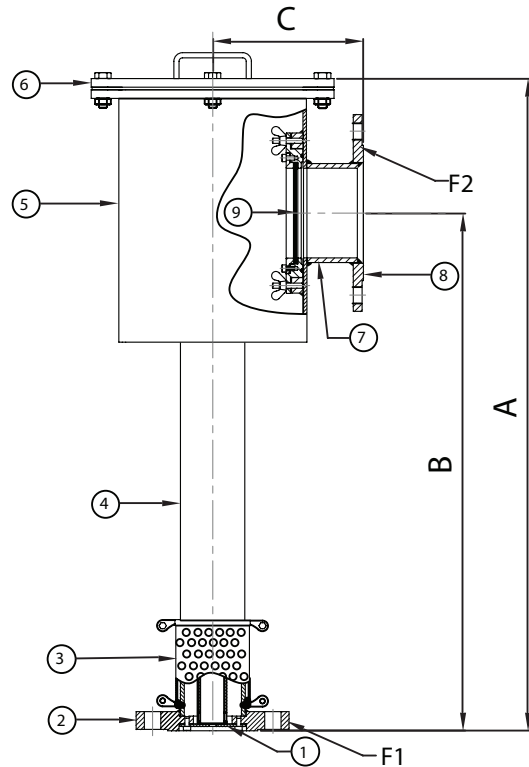

PART LIST

ITEM NO.	DESCRIPTION	MATERIAL SPECIFICATON	
		FCA	FCA-S
1	ORIFICE ASSEMBLY	STAINLESS STEEL	STAINLESS STEEL
2	INLET FLANGE	STEEL	STAINLESS STEEL
3	STRAINER ASSEMBLY	STAINLESS STEEL	STAINLESS STEEL
4	FOAM MAKING CHAMBER	STEEL	STAINLESS STEEL
5	FOAM CHAMBER	STEEL	STAINLESS STEEL
6	INSPECTION COVER	STEEL	STAINLESS STEEL
7	DISCHARGE PIPE	STEEL	STAINLESS STEEL
8	OUTLET FLANGE	STEEL	STAINLESS STEEL
9	VAPOUR SEAL ASSEMBLY	GLASS	GLASS

NOTE:

1. Strainer Assembly consists of SS perforated sheet, SS Strainer holder & Galvanised Nut/Bolt.
2. Vapour Seal is Glass as standard supply (UL & FM Approved) & Graphite disc is optional only for FM Approved model.
3. Pipes used are ERW (Seamless Pipes are optional)
4. Foam chambers are open to atmosphere & do not have internal shutoff device, hence no hydrotest is offered during inspection.

TYPICAL FOAM CHAMBER INSTALLATION WITH DEFLECTOR

TYPICAL INSTALLATION OF FOAM CHAMBER WITH STUD MOUNTING PAD AND SPLIT DEFLECTOR

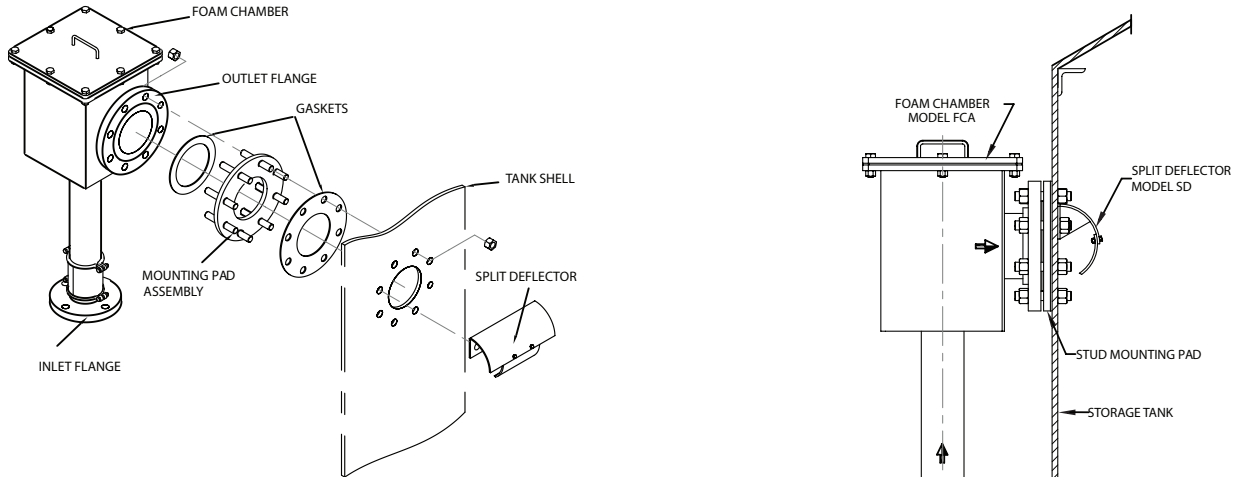

NOTE: Stud Mounting Pad with gasket & split deflector are optional items. To be ordered separately.

TANK CUTOUT FOR MOUNTING OF SPLIT DEFLECTOR

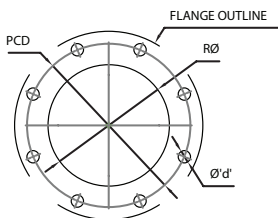

FOAM CHAMBER SIZE			CUTOUT SIZE			
TYPE	INLET FLANGE SIZE	OUTLET FLANGE SIZE	R ϕ	PCD	HOLE $\phi'd$	NO OF HOLES
FCA 50	50	80	90.7	152.4	19	4
FCA 65	65	100	116	190.5	19	8
FCA 80	80	150	170	241	22	8
FCA 100	100	200	221	298	22	8
FCA 150	150	250	276	362	25	12

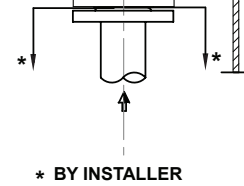

TYPICAL INSTALLATION OF FOAM CHAMBER WITH STUD FLANGED TANK NOZZLE AND SOLID DEFLECTOR

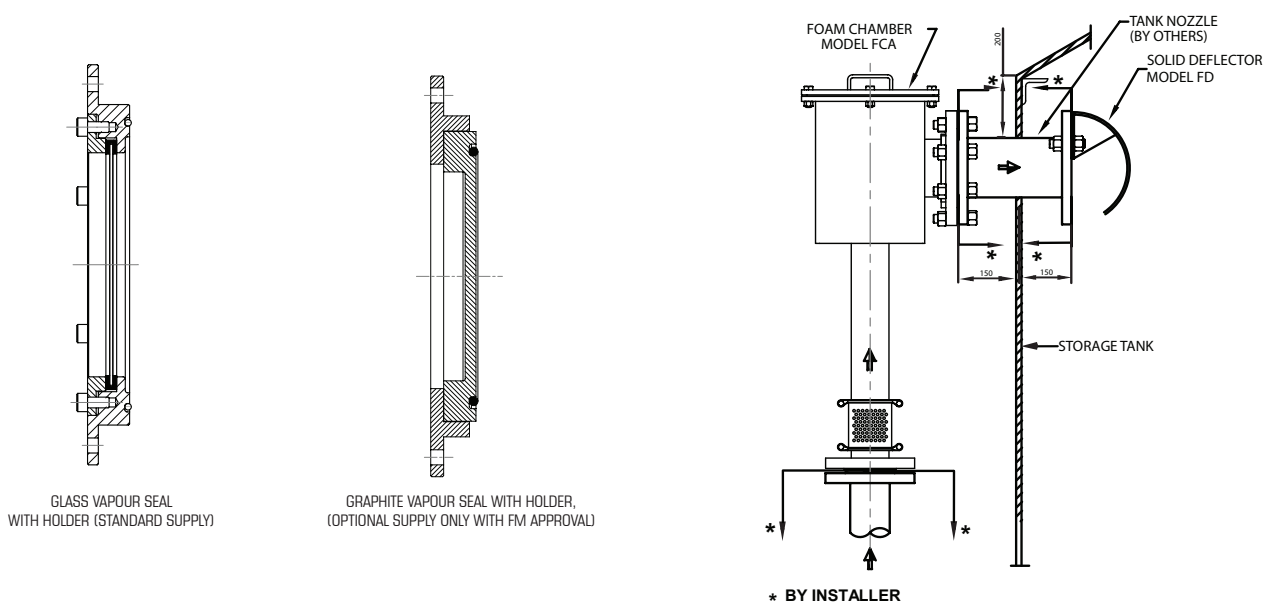

NOTE:

1. Above dimensions are general guidelines only. The system designer can adopt the dimensions as per NFPA/TAC/OISD or as per the governing rules & ordinance having local jurisdiction.
2. Tank nozzle, nut-bolts & gaskets are optional, to be ordered separately.
3. Split deflector Model SD and solid deflector Model FD is standard supply in carbon steel material and optional in stainless steel.

**PRESSURE VS FLOW PERFORMANCE CHARACTERISTIC
UL LISTED WITH FOAM CONCENTRATE AFFF 3% & AR-AFFF 3x3%**

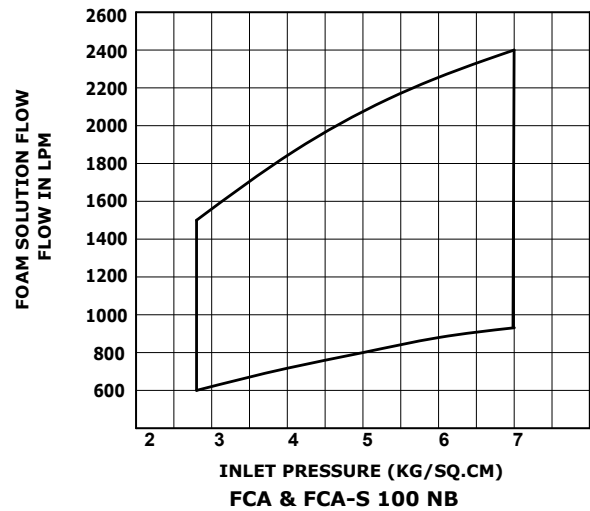
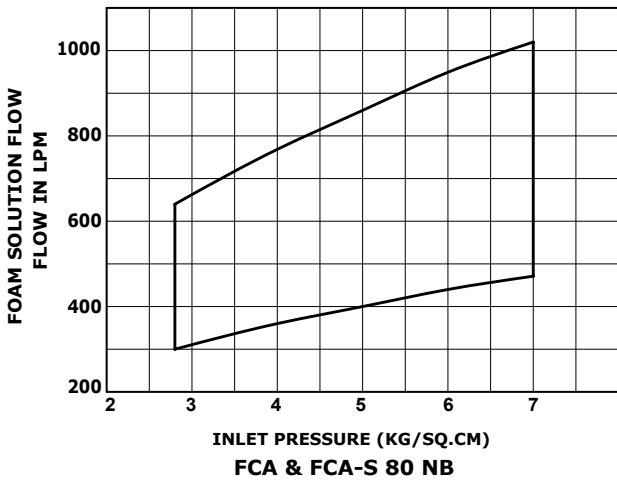
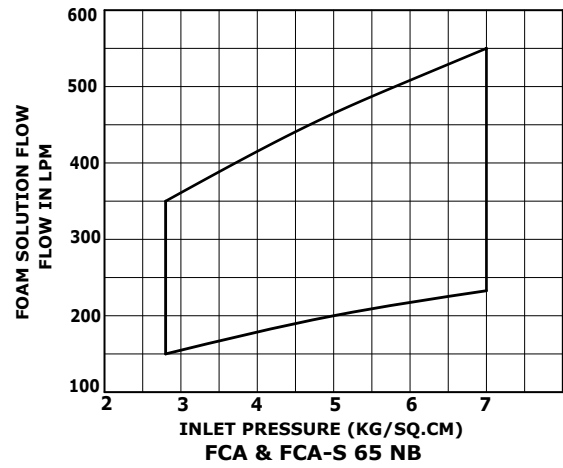
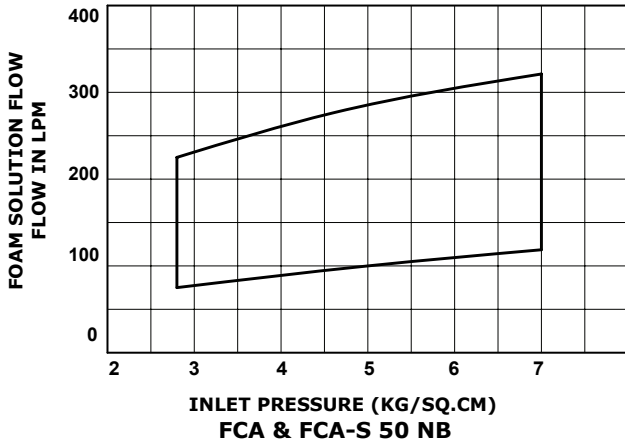

**PRESSURE VS FLOW PERFORMANCE CHARACTERISTIC
FM APPROVED WITH FOAM CONCENTRATE AFFF 3%**

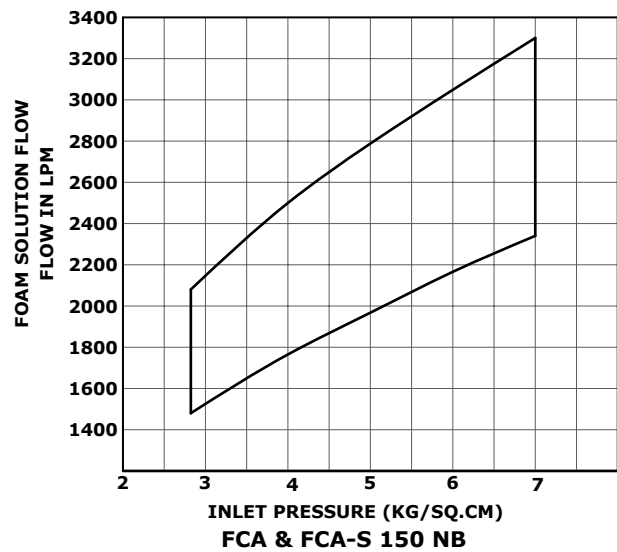
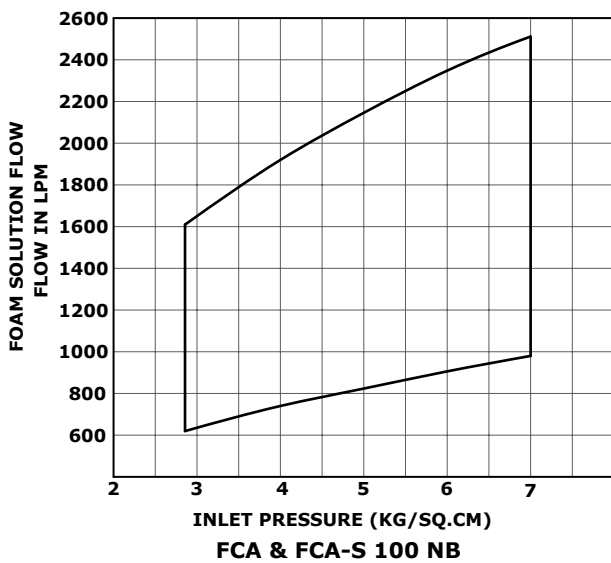
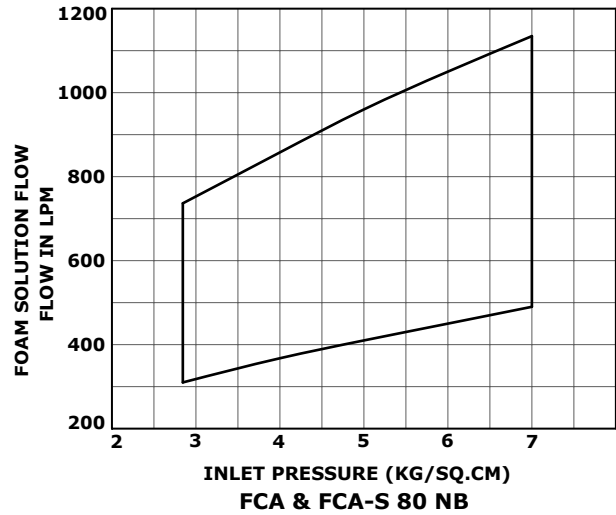
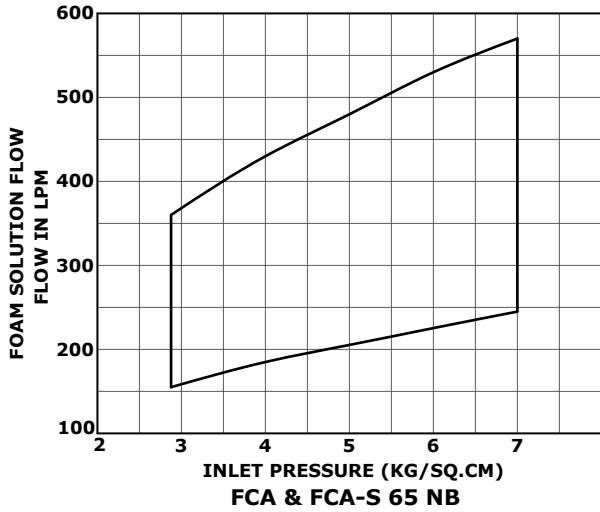

**PRESSURE VS FLOW PERFORMANCE CHARACTERISTIC
FM APPROVED WITH FOAM CONCENTRATE AR-AFFF 3X3-C6**

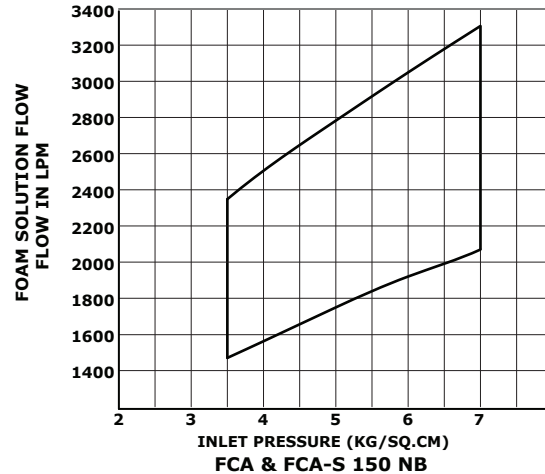
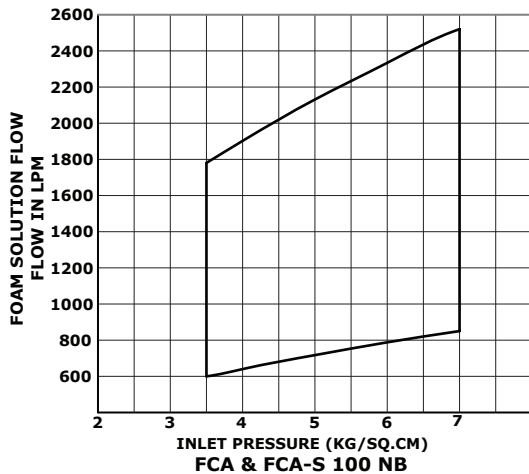
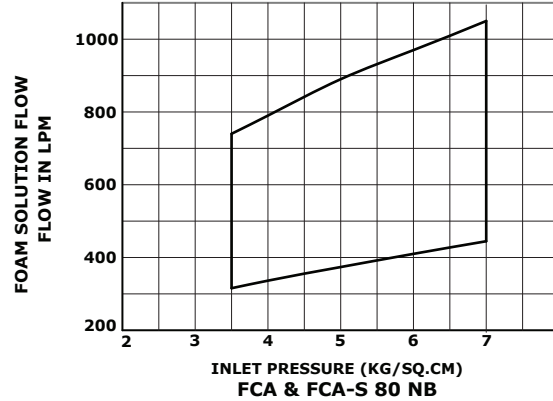
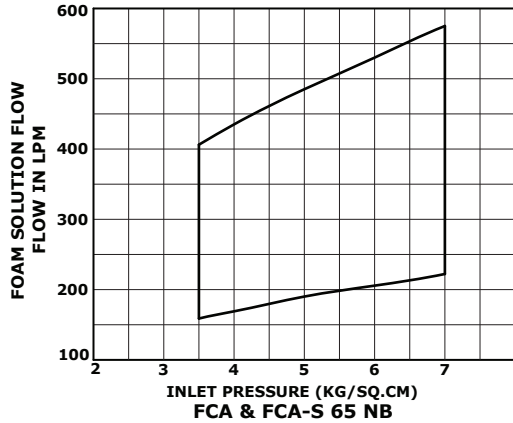

LIMITED WARRANTY

HD FIRE PROTECT PVT. LTD. hereby referred to as HD FIRE warrants to the original purchaser of the fire protection products manufactured by HD FIRE and to any other person to whom such equipment is transferred, that such products will be free from defect in material and workmanship under normal use and care, for two (2) years from the date of shipment by HD FIRE. Products or Components supplied or used by HD FIRE, but manufactured by others, are warranted only to the extent of the manufacturer's warranty. No warranty is given for product or components which have been subject to misuse, improper installation, corrosion, unauthorized repair, alteration or un-maintained. HD FIRE shall not be responsible for system design errors or improper installation or inaccurate or incomplete information supplied by buyer or buyer's representatives. HD FIRE will repair or replace defective material free of charge, which is returned to our factory, transportation charge prepaid, provided after our inspection the material is found to have been defective at the time of initial shipment from our works. HD FIRE shall not be liable for any incidental or consequential loss, damage or expense arising directly or indirectly from the use of the product including damages for injury to person, damages to property and penalties resulting from any products and components manufactured by HD FIRE. HD FIRE shall not be liable for any damages or labour charges or expense in making repair or adjustment to the product. HD FIRE shall not be liable for any damages or charges sustained in the adaptation or use of its engineering data & services. In no event shall HD Fire's product liability exceed an amount equal to the sale price. The foregoing warranty is exclusive and in lieu of all other warranties and representation whether expressed, implied, oral or written, including but not limited to, any implied warranties or merchantability or fitness for a particular purpose. All such other warranties and representations are hereby cancelled.

NOTICE :

The equipment presented in this bulletin is to be installed in accordance with the latest publication standards of NFPA or other similar organisations and also with the provision of government codes or ordinances wherever applicable. The information provided by us is to the best of our knowledge and belief, and consist of general guidelines only. Site handling and installation control is not in our scope. Hence we give no guarantee for result and take no liability for damages, loss or penalties whatsoever, resulting from our suggestion, information, recommendation or damages due to our product. Product development is a continuous programme of HD FIRE PROTECT PVT. LTD. and hence the right to modify any specification without prior notice is reserved with the company.